

Student Application Procedure

Guide



Exchange student Application deadlines

Application deadline	Fall Semester 2023	Spring Semester 2024	Full Academic Year 2023/2024
Non-EU citizens	May 15, 2023	October 15, 2023	May 15, 2023
EU citizens	May 31, 2023	October 31, 2023	May 31, 2023

1. Log into the university system InSIS



Personal administration

- [Log in to the Personal administration of InSIS](#) • [First log in to InSIS instructions](#) • [System integrators](#)



Admission procedure

- [E-application form to study at VŠE](#) • [Admission procedure results](#) • [Pre-enrollment confirmation for application to study at VŠE](#)
- [Application to U3V](#)



Information about VŠE

- [Persons at VŠE](#) • [Validity verification of identification cards](#) • [Departments](#) • [Thematic search](#) • [Types of ID cards in use](#)
- [Public document server](#)

2. Go to "My College" and press the small button on the right to get the full offer

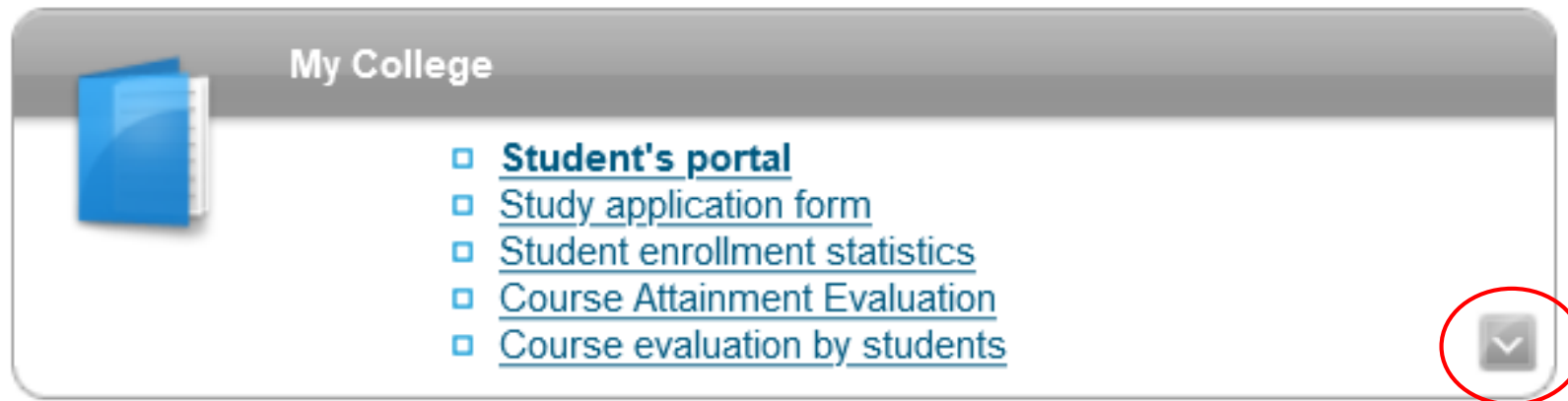



3. Choose "Application to exchange programme - add personal details"

[Search](#) [Open all](#)

My College



- [Student's portal](#)
- [Course Attainment Evaluation](#)
- [Course evaluation by students](#)
- [Study application form](#)
- [Student enrollment statistics](#)
- [Application to exchange programme - add personal details](#)



4. Enter your contact details, personal information...

- ▶ When filling out **Country** and **Country of birth**, do not forget to open the scrollbar and choose one of the listed countries

Address

Use the following form to enter information regarding permanent residence. In the Note box type address information (room no., flat owner name).

Street	<input type="text"/>	Number	<input type="text"/>	Post code	<input type="text"/>	<input type="button" value="Search"/>
Town	<input type="text"/>					
Country	<input type="text" value="Czech Republic"/>					
Note	<input type="text"/>					

Personal data

Use the following form to complete personal details.

Place of birth	<input type="text"/>
Country of birth (compulsory)	<input type="text" value="Czech Republic"/>
State citizenship (compulsory)	<input type="text" value="United States of America"/>
Telephone number (compulsory)	<input type="text"/>

4. Enter your contact details, personal information...

- ▶ ... When you have filled everything in, click on „**Save entered information**“ button
- ▶ **EU citizens** leave the section Czech Embassy blank
- ▶ **Non-EU citizens** can find the list of Czech diplomatic missions abroad [here](#)

Add personal details

Basic information

Use this application to enter user's additional data.

Address

Use the following form to enter information regarding permanent residence. In the Note box type address information (room no., flat owner name).

Street: Number: Post code:

Town:

Country:

Note:

Personal data

Use the following form to complete personal details.

Place of birth:

Country of birth (compulsory):

State citizenship (compulsory):

Telephone number (compulsory):

I was awarded the Czech permanent residency (the Czech permanent residency is a plastic card issued by the Ministry of Interior of the Czech Republic) (compulsory): yes no

VISA application will be submitted at the Czech Embassy/Consulate in (English name of the city and the country; e.g. Beijing, China):

Passport number (compulsory):

Emergency phone number (compulsory):

 Clicking on the "Save entered information" button, I agree that my data is collected, kept and processed by course of the 101/2000 Sb. Personal Data Protection Act as amended, by the Prague University of Economics and Business, Nám. Winstona Churchilla 4, 130 67 Praha 3, Czech Republic. This assent is granted on a voluntary basis in the above mentioned extent and for the time period essentially needed.

5. Upload your photo according to the guidelines

- ▶ After entering all your personal details, go back to the InSIS main page and choose **Student's portal** in the section „My college“

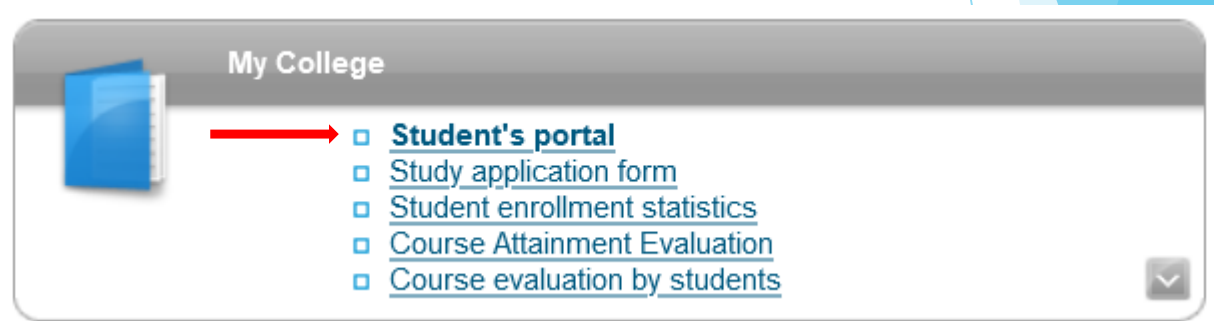

- ▶ Scroll down and upload your photo

Student card

Applications which are not directly bonded to the selected study may be relevant for it though.



5. Upload your photo according to the guidelines

- ▶ ONLY a digital **passport size photo**, a .jpeg file, max. 2 MB, **plain background**
- ▶ The photo serves for preparing your **VSE student ID card** prior to your arrival and needs to fulfill the **legal requirements**:
 - ▶ The image size is not smaller than the outer frame of gray area
 - ▶ **Head size** between inner and outer circle is not over 35 mm and less than 31 mm
 - ▶ Eyes between the dashed line and on the same level
 - ▶ Taken in **full-face view** directly facing the camera, **one person** in shot only
 - ▶ With a **neutral facial expression**, **both eyes open** and showing a **full head**
 - ▶ The photo must be **clear**, in **sharp focus**, in **color**, no shadows in the background

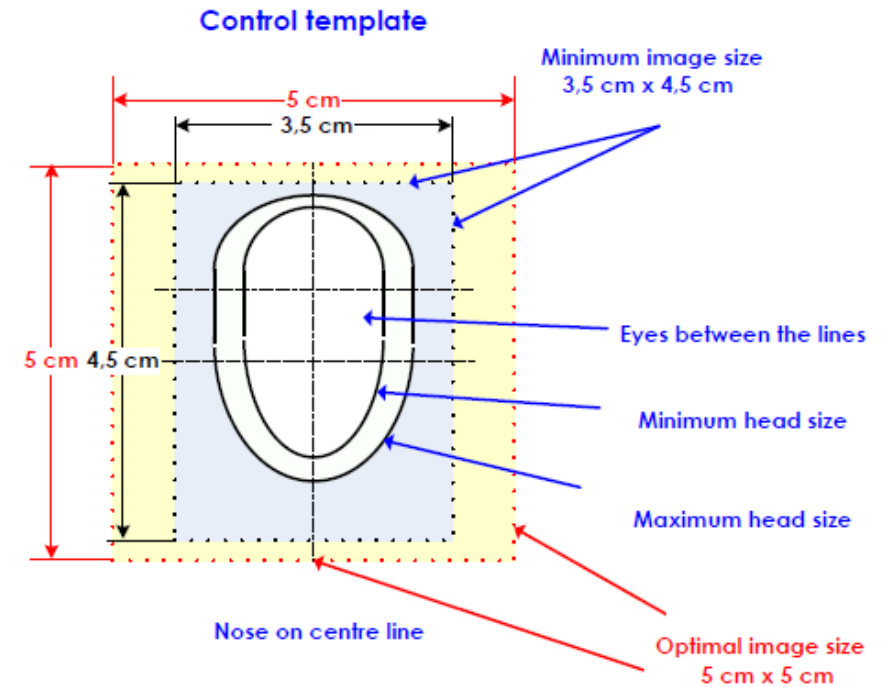

5. Upload your photo according to the guidelines

- ▶ Example of an **approved** photo
- ▶ If your photo does not meet the criteria stated in the **guidelines**, it **will not be accepted** and you will have to upload another one.



5. Upload your photo according to the guidelines

Change photo

Use the application to enter photo. Photo must be in JPEG format.



Loading photograph from disc (only JPEG, max. size 5 MB):

Procházet...

Save photo

Approval of photo

By confirming all the following approvals you consent to your photograph being visible in Integrated Study Information System.

Consent to the Processing of Photograph in the Information Systems of the VŠE

Approval was not granted.
Version: 11/11/2020 15:18



[... more](#)

Do not forget to approve the Consent of the Processing of Photograph



Approval of photo

By confirming all the following approvals you consent to your photograph being visible in Integrated Study Information System.

Consent to the Processing of Photograph in the Information Systems of the VŠE

Approval was granted.



[... more](#)

[Key](#) (click to show/hide)



6. Personal data check

- ▶ After entering all your personal details and your photo, go back to the InSIS main page and choose **Personal data check** in the section „Protection of personal data“

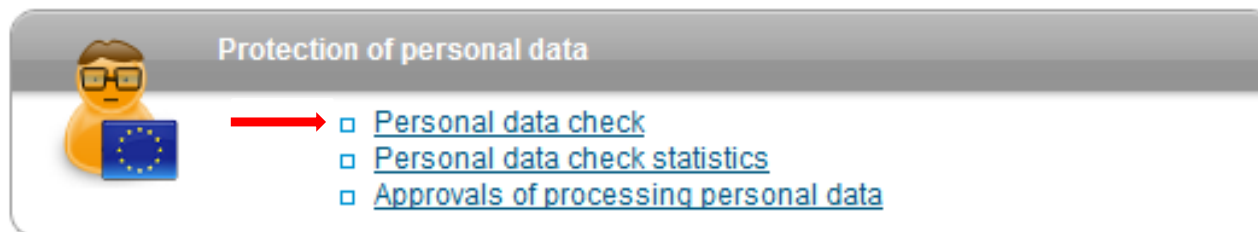

6. Personal data check

- ▶ Look at all your personal data displayed and check if it is correct
- ▶ If there is any kind of a mistake, please contact the Exchange Office (exchange@vse.cz)
- ▶ You can disregard the section regarding the bank account
- ▶ **Please pay special attention to the following fields:**

- ▶ **Name and surname** - the right order of your full name - see below:

John	Fitzgerald	Kennedy
= Name	= Middle Name	= Last Name
= First Name		= Family Name
= Given Name		= Surname
= Prénom		= Nom

Please include the possible middle name(s) to the Name box.

- ▶ **Date of birth** - date of birth is displayed in the following format: DD/MM/YYYY
- ▶ **Sex**

Personal information

The following information about staff is partly provided by HR and IFIS system preferences.

Name	Entry	Changed
First name and surname	[REDACTED]	04/04/2017
Identification number	[REDACTED]	04/04/2017
Date of birth	[REDACTED] (DD/MM/YYYY)	04/04/2017
Sex	male	04/04/2017
Personal code	[REDACTED]	04/04/2017
Citizenship qualifier	[REDACTED]	04/04/2017
State citizenship	[REDACTED]	04/04/2017
E-mail	[REDACTED]	04/04/2017

7. Confirm personal data information

- ▶ If your data is alright, click on the „I confirm that the above given information is correct“ button.
- ▶ **This is the last step, no confirmation that you have filled in the application will be provided!**
- ▶ Once the online Application has been filled in and processed in the system, your Letter of Acceptance will be uploaded in the InSIS Document Storage (all students). Moreover, non-EU citizens will be sent their VISA Supporting Documents to their home university.
- ▶ Notification by email - for both the Letter of Acceptance and the Supporting Documents.

